

Owner's Manual



Powered by
Sterilight

Models:
S2Q-OZ, S2Q-OZ/2, S8Q-OZ, S8Q-OZ/2

Congratulations

on the purchase of your ultraviolet (UV) water disinfection system! This system uses the most advanced UV technology on the market and is designed to provide you with years of trouble free operation with minimal maintenance required to protect your drinking water from microbiological contaminants.

To ensure ongoing disinfection of your water, UV lamps need to be replaced annually with VIQUA factory-supplied replacements. VIQUA lamps are the result of extensive development resulting in a highly efficient disinfection platform with extremely stable UV output over the entire 9000 hour lifetime. Its success has led to a proliferation of non-genuine copies in the market.

The UV lamp is the heart of the disinfection system, and there should be no compromise when it's time for a replacement.

Why should you insist on genuine factory supplied VIQUA replacement lamps?

- Use of widely available, non-genuine, replacement lamps has been shown to damage the control module of VIQUA UV disinfection equipment.
- An increasing number of calls to VIQUA Technical Support are connected with non-genuine lamps being used (unknowingly) as replacements.
- Damage arising from the use of non-genuine lamps poses a safety risk and is not covered by equipment warranty.
- Unless the UV equipment is equipped with a UV sensor (monitor), it is not possible to verify the UV (invisible) output of replacement lamps.
- Similar appearance to the original lamp and the presence of (visible) blue light does not mean equivalent disinfection performance.
- VIQUA replacement lamps undergo rigorous performance testing and strict quality control processes to ensure that the safety and performance certifications of the original equipment are not compromised.

So, you can see that it's simply not worth the risk! Insist on genuine VIQUA replacement lamps.















Section 1 Safety Information

These are the original instructions. Please read this entire manual before operating this equipment. Pay attention to all danger, warning, and caution statements in this manual. Failure to do so could result in serious personal injury or damage to the equipment.

Make sure that the protection provided by this equipment is not impaired. Do not use or install this equipment in any manner other than that specified in the installation manual.

1.1 Potential Hazards:

Read all labels and tags attached to the system. Personal injury or damage to the system could occur if not observed.



	Waste electrical and electronic equipment (WEEE). This symbol indicates that you should not discard wasted electrical or electronic equipment (WEEE) in the trash. For proper disposal, contact your local recycling/reuse or hazardous waste center.		This symbol indicates that the contents of the transport package are fragile and the package should be handled with care.
	This symbol indicates there is Mercury present.		This symbol indicates a safety glasses with side protection is required for protection against UV exposure.
	This is the safety alert symbol. Obey all safety messages that follow this symbol to avoid potential injury. When on the equipment, refer to the Operational and Maintenance manual for additional safety information.		This symbol indicates gloves must be worn.
	This symbol indicates a risk of electrical shock and/or electrocution exists.		This symbol indicates safety boots must be worn.
	This symbol indicates there is a potential UV hazard. Proper protection must be worn.		This symbol indicates the operator must read all available documentation to perform required procedures.
	This symbol indicates the marked item could be hot and should not be touched without care.		This symbol indicates the plumber must use copper piping.
	This symbol indicates not to store any combustible or flammable material close to the system.		This symbol indicates that the system should only be connected to a properly grounded, grounding-type power supply receptacle that is protected by a Ground Fault Circuit Interrupter (GFCI).

Warning: This product may contain chemicals known to the State of California to cause cancer and birth defects or other reproductive harm.

1.2 Safety Precautions:

IMPORTANT SAFETY INSTRUCTIONS. READ AND FOLLOW ALL INSTRUCTIONS. SAVE THESE INSTRUCTIONS.

⚠ DANGER

 	<p>Failure to follow these instructions will result in serious injury or death.</p> <ul style="list-style-type: none"> Electric Shock: To avoid possible electric shock, special care should be taken since water is present near the electrical equipment. Unless a situation is encountered that is explicitly addressed by the provided maintenance and troubleshooting sections, do not attempt repairs yourself, refer to an authorized service facility. Risk of electric shock. Connect this ozone generator in accordance with the installation instructions. Do not install under the skirt of a spa or hot tub or within an enclosure that would restrict ventilation. GROUNDING: This product must be grounded. If it should malfunction or breakdown, grounding provides a path of least resistance for electric current to reduce the risk of electrical shock. This system is equipped with a cord having an equipment-grounding conductor and a grounding plug. The plug must be plugged into an appropriate outlet that is properly installed and grounded in accordance with all local codes and ordinances. Improper connection of the equipment-grounding conductor can result in a risk of electrocution. Check with a qualified electrician or service personnel if you are in doubt as to whether the outlet is properly grounded. Do not modify the plug provided with this system – if it does not fit in the outlet, have a proper outlet installed by a qualified electrician. Do not use any type of adapter with this system. GROUND FAULT CIRCUIT INTERRUPTER PROTECTION: To comply with the National Electrical Code (NFPA 70) and to provide additional protection from the risk of electric shock, this system should only be connected to a properly grounded, grounding-type power supply receptacle that is protected by a Ground Fault Circuit Interrupter (GFCI) or to a residual current device (RCD) having a rated residual operating current not exceeding 30 mA. Inspect operation of GFCI as per manufacturer’s suggested maintenance schedule. DO NOT operate the disinfection system if it has a damaged cord or plug, if it is malfunctioning or if it has been dropped or damaged in any manner. DO NOT use this disinfection system for other than intended use (potable water applications). The use of attachments not recommended or sold by the manufacturer / distributor may cause an unsafe condition. DO NOT install this disinfection system where it will be exposed to the weather or to temperatures below freezing. DO NOT store this disinfection system where it will be exposed to the weather. DO NOT store this disinfection system where it will be exposed to temperatures below freezing unless all water has been drained from it and the water supply has been disconnected.
--	--

Safety Information

⚠ WARNING



- This system contains a UV Lamp. Do not operate the UV Lamp when it is removed from the chamber. Unintended use or damage of the system may result in the exposure of dangerous UV radiation. UV radiation may, even in little doses, cause harm to the eyes and skin.
- Short term inhalation of high concentrations of ozone can cause serious harmful physiological effects. Do not inhale ozone gas produced by this device.
- Changes or modifications made to this system without the consent of the manufacturer could render the system unsafe for operation and may void the manufacturer's warranty.

⚠ CAUTION



Failure to follow these instructions could result in minor or moderate injury.



- Carefully examine the disinfection system after installation. It should not be plugged in if there is water on parts not intended to be wet such as, the controller or lamp connector.
- **Hg EXPOSURE:** The UV lamp contains mercury. If the lamp breaks, then avoid inhalation or ingestion of the debris and avoid exposure to eyes and skin. Never use a vacuum cleaner to clean up a broken lamp as this may scatter the spilled mercury. Obey local regulations and guidelines for the removal and disposal of mercury waste.

NOTICE



- These instructions apply to the installation in a swimming pool and/or spa. Although these instructions do not cover typical water treatment applications, it should be noted that this equipment can be used in this type of application.
- Install at least 5 ft. from tub water using nonmetallic plumbing. Install ozone generator no less than 1 ft. above the maximum water level to prevent water from contacting electrical equipment. Install in accordance with the installation instructions.
- The UV lamp inside the disinfection system is rated at an effective life of approximately 9000 hours. To ensure continuous protection, replace the UV lamp annually.
- The UV system is not to be used or played with by children. Persons with reduced physical, sensory or mental capabilities, or lack of experience and knowledge, are also not to handle the UV system unless they have been given supervision or instruction.
- This system is intended to be permanently connected to the water lines.
- This system is not intended to be used in or above water or outdoors or used in swimming pools when persons are in the pool.
- **EXTENSION CORDS:** If an extension cord is necessary, use only 3-wire extension cords that have 3-prong grounding-type plugs and 3-pole cord connectors that accept the plug from this system. Use only extension cords that are intended for outdoor use. Use only extension cords having an electrical rating not less than the rating of the system. A cord rated for less amperes or watts than this system rating may overheat. Exercise caution when arranging the cord so that it will not be tripped over or pulled. Do not use damaged extension cords. Examine extension cord before using and replace if damaged. Do not abuse extension cord. Keep extension cord away from heat and sharp edges. Always disconnect the extension cord from the receptacle before disconnecting this system from the extension cord. Never yank cord to pull plug from outlet. Always grasp the plug and pull to disconnect.
- If the supply cord is damaged, it must be replaced by a special cord or assembly available from the manufacturer or its service agent.
- **SYSTEM PROTECTION:** To protect your Controller, a UL1449 certified (or equivalent) transient voltage surge suppressor is strongly recommended.
- Read and understand the Operation and Maintenance Manual before operating and performing any maintenance on this equipment.

Section 2 General Information

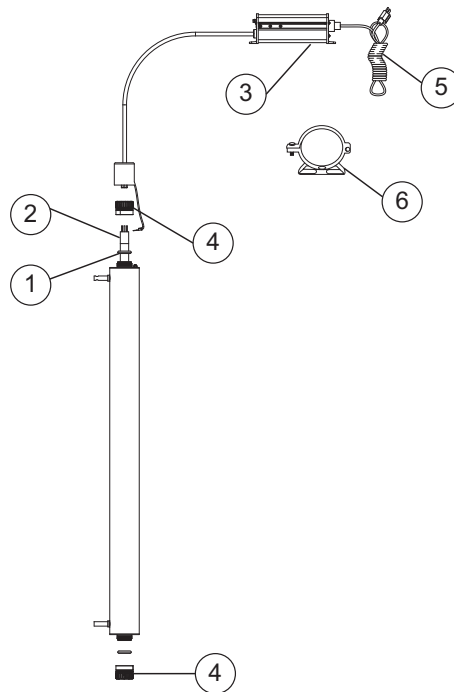

Figure 1 System Components

Item	Description	Part Number	UV Systems
1	O-ring	410933-R	S2Q-OZ, S2Q-OZ/2, S8Q-OZ, S8Q-OZ/2
2	UV lamp	S415ROL	S2Q-OZ, S2Q-OZ/2
		S8ROL/4P	S8Q-OZ, S8Q-OZ/2
3	Controller (100-240V/50-60 Hz)	BA-ICE-SO	S2Q-OZ, S2Q-OZ/2, S8Q-OZ, S8Q-OZ/2
4	Retaining nut	RN-001	S2Q-OZ, S2Q-OZ/2, S8Q-OZ, S8Q-OZ/2
5	IEC replacement power cords for VIQUA ICE Controller (sold separately)	602636	NORTH AMERICAN (NEMA 5-15P), 3-PRONG GROUNDED
		602637	CONTINENTAL EUROPEAN (CEE 7/7) 2-PIN WITH GROUND, "SCHUKO"
6	2.5" Mounting brackets	410958-R	S2Q-OZ, S2Q-OZ/2, S8Q-OZ, S8Q-OZ/2

2.1 Introduction to Ozone

Ozone is nature's natural purifier. This naturally occurring product is produced during lightning and electrical storms as well as when solar ultraviolet rays strike the earth's upper atmosphere. It is this ozone layer which protects us from the harmful UV radiation produced by the sun.

Ozone is generated when an oxygen molecule (O_2) is exposed to high energy, ultraviolet (UV) light and is converted to an ozone (O_3) molecule. This extra oxygen atom is what makes ozone a highly "energetic" oxidizer.

Ozone's effects come when this "extra" oxygen atom is released and allowed to oxidize and destroy bacteria, viruses, as well as other organic matter in the pool or spa. Ozone can also break down harmful chemicals and act as a flocculant to coagulate various insoluble particles which can then be easily removed by the filtration system.

Ozone's powerful oxidizing abilities work in conjunction with your sanitizing agent to provide a healthier, cleaner bathing experience. As an oxidizer, ozone eliminates objectionable chemical by-products such as chloramine or bromamine - the result, a totally environmentally safe product.

2.2 System Features

- All models include an LED Indicator display to indicate that the lamp is operating. They also include an audible lamp out alarm, which will sound if the lamp fails to start.

Installation

- The UV lamp is contained inside of a sealed stainless steel ozone generator cell which protects the electrical components and outer case from the oxidizing effects of ozone.
- 185nm ultraviolet lamps can be replaced or cleaned by simply loosening the gland nuts from the ends of the stainless steel ozone generating cell, removing the old lamp and re-installing or installing a new UV lamp.

Section 3 Installation

3.1 Ozone Generator

▲ WARNING

- Do not look directly into the ports. ultraviolet light emitted by the lamp can cause burns to unprotected eyes.

- The S2Q-OZ will generate sufficient ozone for most spa and hot tub applications subject to the wide variations that occur depending on operating conditions, chemical control and bather load.
- Model S8Q-OZ is sufficient for smaller pools and can be used in parallel for larger applications. Sizing will also be dependent on a wide range of variations including operating conditions, chemical control and bather load.
- Choose a location for your generator that is accessible to an approved electrical outlet and where the indicator light is visible.

Note: Electrical outlets within 10 feet of the tub must have ground fault protection.

- Leave enough space to allow for removal of the UV lamp for lamp maintenance.
- As UV lamps can be damaged in shipping and handling, check the lamp before installing your ozone generator by plugging it into an electrical outlet for a moment. A bluish light should be evident at the ports and the LCD display on the controller should illuminate.

Your ozone generator should be located in a dry area that is accessible for servicing and at least two feet above the water level. If the unit can not be mounted at least two feet above the water level, the tubing connecting the generator to the inlet of the spa or pool must either be installed with a loop to raise it two feet above the water level or be fitted with a check valve approved for ozone service to prevent water back flow into the generator. When using an optional venturi system to provide increased air flow, a check valve must be used to prevent back flow into the generator in case the outlet line is blocked.

Select a location two feet above the water level and with access to a properly grounded electrical outlet. The unit can be mounted vertically or horizontally with the connection ports facing down. Mount the chamber to the wall using the cell clamp and mounting screws included with your system. If mounting the unit to drywall, use a plug or an expansion butterfly nut to secure the unit.

Some typical installation procedures are:

3.1.1 Pressure Differential System for Ozone Eduction System Part Number OE-001

Recommended for most spa installations. This simple pre-assembled system utilizes a combination of pressure differential, venturi and the spas existing air induction piping, offering the most efficient and economical ozone mixing and distribution, virtually eliminating any gas off. Please note in the illustration below that water from the high pressure side of the pump is forced through an aspirator or venturi which causes air suction. This air suction pulls ozone in from the ozone generator thereby mixing the ozone and water at the aspirator where injection takes place. Then the mixed ozone and water travels through a 3/8" tube to the spas air induction line. On the way back to the air line the ozone and water is retained in a loop in the 3/8" line to cause thorough mixing and ozone absorption in the water prior to injection into the spas air line. Reduce the water level until it is below the air induction line (if necessary) to avoid water leakage when making the connections. NOTE: ozone may cause rubber seals in the system to degenerate. These parts should be replaced with "Viton" or other material resistant to ozone.

OE-001 Installation Kit**Parts List:**

- 310019 3/8" I.D. Tubing
- PF-3003 Venturi Tubing
- CHK-01B Check Valve
- HB-375 1/4" Male Adaptor

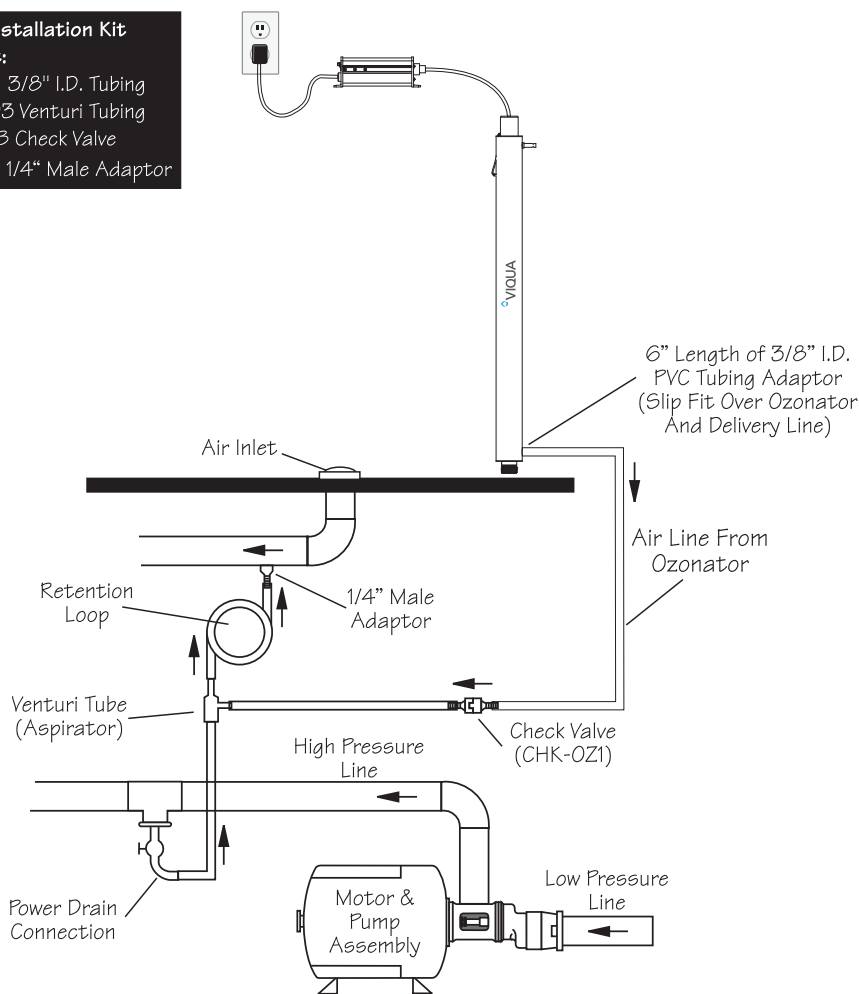

Figure 2 Pressure Differential System

Your spa may have come equipped with a 1/4" NPT threaded inlet on the air line, if not you may be required to drill and tap a 1/4" NPT hole to install the 1/4" NPT to barbed adaptor that comes with the OE-001 kit. The location for the ozone injection point will be decided by where you choose to place the adaptor. Normally the placement of the adaptor will allow the ozone to flow through only one side of the tub. If possible, choose the air line with the most attached jets to take full advantage of the injection points. If drilling, place the adaptor downstream of the air vent controls. Your spa may have also come supplied with a garden hose threaded tap on the HIGH PRESSURE SIDE of the pump, which is commonly referred to as a power drain. If your spa has no power drain, then the optional saddle clamp must be installed on the HIGH PRESSURE side of the pump as close to the pump as possible. If you are not sure which is the high pressure side, be sure to contact your dealer to avoid any irreversible drilling. After you have located or installed the barbed adaptor on the air line and the adaptor on the water line, simply hook up the eduction system as the diagram illustrates. Make sure all the connections are sealed so no leaking will occur.

After all the water connections have been made you must choose a location for your ozonator. If you are locating the ozonator below the water level an approved check valve (model #CHK-01B) must be used on the ozone induction air line from the ozonator and the unit be hooked into an approved ground fault protected electrical supply. After the system is totally installed, re-fill the tub. When tub level is correct, thoroughly inspect the system for leaks. If your spa was equipped with a power drain, remember you must turn on the tap to allow water to pump through the system. If no leaks are found turn the power on to the tub and open the jet that has the ozonated water connected to it and re-check for leaks. When the unit is on high speed you should be able to detect suction at the inlet on the ozonator. If it can't be detected, take the air line off at the venturi to check the air draw into the venturi at high speed. At low speed the air draw will be dramatically reduced, don't be alarmed, there should only be a slight air draw at low speed. The retention loop has been incorporated to keep the ozone in contact with the water prior to induction into the spa. This will cause excellent ozone absorption and mixing. If you have a dominant ozone smell on high speed you simply need to increase the number of loops with an optional connector until the ozone smell is almost eliminated. You should smell a slight hint of ozone at the jet that is introducing the ozone. If you have no smell at all, simply cut the loop number back until you do smell a hint of ozone at high speed. ozone has a distinct fresh or pungent odour.

3.1.2 Water Venturi System for Pools and Some Large Spas

A venturi draws air by forcing a set amount (or flow rate) of water through a pipe that gradually reduces in size and at the smallest point in the pipe the venturi action (or air suction) is created. A venturi or venturi system (Refer [Figure 3](#)) must be selected to match the pump flow. Install the venturi on the discharge side of the pump and after the filter. On large systems, the venturi may create an unacceptable pressure drop, if so, a by-pass ball valve or spring loaded check valve can be installed. To increase the draw with a venturi system that incorporates a ball valve, simply adjust, or slowly close the ball valve. This will create a back pressure in the bottom pipe (Refer [Figure 3](#)) which will force water up to and through the venturi, thereby increasing draw (or suction). A spring loaded by-pass check valve is suggested for two speed pump systems (usually used on spas) to provide an automatic flow adjustment. The optional one inch venturi has a flow rating of 20 gpm and the 1.5 inch venturi is rated for 60 gpm with a 5 psi pressure drop. A ball valve by-pass is required for flows over the rated flow of the venturi. A ball valve by-pass venturi system (Refer [Figure 3](#)) is recommended for any pool installation, to offer a full range of adjustability.

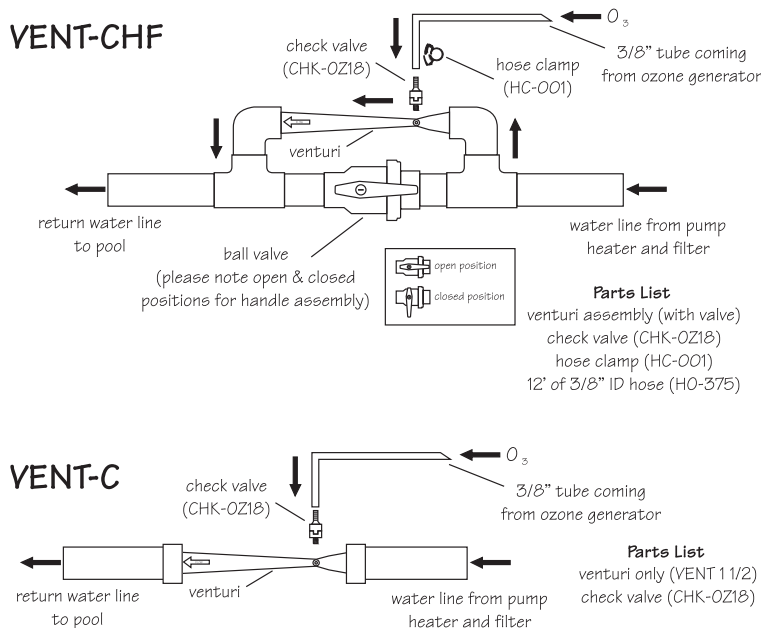

Figure 3 Water Venturi System

Section 4 Maintenance

⚠ WARNING

- Always disconnect power before performing any work on the disinfection system.
- Always shut-off water flow and release water pressure before servicing.
- Regularly inspect your disinfection system to ensure that the power indicators are on and no alarms are present.
- Replace the UV lamp annually (or biennially if seasonal home use) to ensure maximum disinfection.
- Always drain the chamber when closing a seasonal home or leaving the unit in an area subject to freezing temperatures.

Regularly inspect your ozone generator unit to ensure that the lamp is still working.

The ultraviolet output of the UV lamp gradually reduces with usage. However, there is a wide variation in the actual amount of ozone required because of differences in the volume of water and the number of people using the hot tub or spa. The condition of the water is a reasonable indicator to tell when a new lamp or maintenance is needed. A large increase in the amount of treatment chemical or a change in the water color or scum on the inside of the tub are all indications that more ozone is required. As dust on the lamp will also reduce output, the lamp should be cleaned first to verify that the lamp needs to be replaced (Refer [Section 4.1](#)). As a general guide, lamp replacement is suggested after 12 to 18 months of continuous operation.

The ozone generator should be on whenever the pump is operating. ozone generation requires a continuous air supply through the cell. The air suction can be produced in various ways, as discussed earlier in the installation section. Although the UV lamp may be left on without the pump operating, there would be no appreciable ozone generation since there would be no air flow in the cell. If the pump is to be off for an extended period of time, the ozone generator should also be shut off. Unlike filters where the amount of water passed through determines the life expectancy, UV ozone generators are effected by the number of hours the lamp burns. Frequent switching off and on can also reduce lamp and ballast life. If your spa experiences heavy bather loads the ozonator jets should be left on high speed for 2 to 5 minutes after use with the spa cover closed, this will increase the amount of injected with the spa cover closed, this will increase the amount of injected ozone thereby reducing the organic load. However, if the water gets very cloudy the organic load may be past the ozonator threshold and you may need to shock after use with a concentrated chemical. If a concentrated shock is even necessary, one treatment will normally suffice.

4.1 Ozone Lamp Cleaning/Replacement

NOTICE

Disconnect the ozone unit power cord from the electrical outlet before replacement of UV lamp.

Remove the cable tie from the rubber boot which secures the UV lamp into the stainless steel reactor chamber. Carefully pull the rubber boot back from the gland nut to expose the UV lamp electrical connection. Disconnect the lamp connector from the UV lamp. Loosen and remove the gland nut which secures the UV lamp into the stainless steel reactor chamber by turning the knurled nut counter-clockwise. Carefully remove the o-ring from the end of the lamp (note that it may be stuck to the lamp) and carefully remove the UV lamp from the stainless steel reactor chamber.

Note: *Lamp Cleaning Carefully clean the lamp with a clean, lint free wiper dampened with vinegar. New lamps should also be wiped clean to remove dust. Do not handle the UV lamp with bare hands to avoid leaving oil and grease contaminants on the lamp.*

4.2 Installing UV lamp

Carefully insert the lamp into the reactor chamber. Install the o-rings onto the UV lamp. Wet o-ring first if necessary to help it slide onto the UV lamp. Install the gland nuts onto the reactor chamber and tighten the gland nut to secure the UV lamp by turning clock wise until tight. Do not over tighten. Connect the Lamp connector to the UV lamp. Apply power briefly to ensure UV lamp illuminates. Slide rubber boot over lamp connector and secure in place with cable tie.

4.3 Lamp Start Up

Plug the ballast power cable into the electrical outlet to check for proper operation. A blue light will be evident at the ports and the display screen on the controller should be illuminated. Do not look directly into the ports.

Since ozone is such a powerful oxidizer, proper maintenance of the filtration equipment is essential. The filter cartridges will become “dirty” much more rapidly than the same system operating without an ozone generator. It is a good idea to have an extra filter cartridge on hand so that one may thoroughly clean the “dirty” cartridge. We recommend using TSP (trisodium phosphate) in conjunction with cold water and allowing the cartridge to soak overnight. Thoroughly rinse the cartridge and reinstall so that all seals or gaskets are seated properly.

Section 5 Operation

5.1 BA-ICE-SO Controller Features

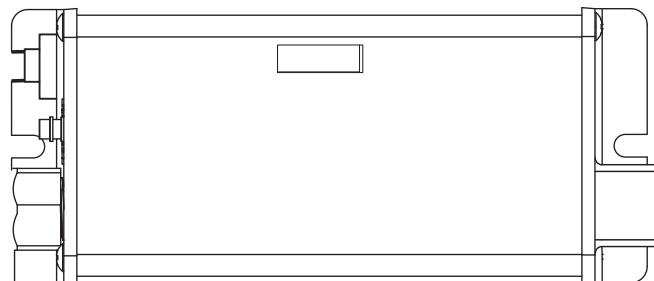

Troubleshooting Guide

5.1.1 Lamp Life Remaining (days)

365 The controller tracks the number of days of operation of the lamp and the controller. The default screen will display the total lamp life remaining (in days). The controller will count down the number of days remaining until the lamp requires changing (365 days to 1 day). At "0" days, the controller will display **A3** on the display and supply an intermittent audible chirp (1 second on, 5 seconds off), indicating the need to change the lamp.

5.1.2 Understanding your "A3" Code

A3 DEFERRAL - Once the "A3" or end of lamp life message is shown on the LED screen, the audible alarm can be deferred up to 4 separate times. The delay is designed to allow you time to address the alarm while you obtain a new UV lamp. This can be done by simply depressing the timer reset button for 5 seconds, which is located on the left side of the controller. Each time the timer reset button is pressed the controller alarm is deferred seven days. Once the final 7 day deferral has been reached the alarm can only be silenced by changing the UV lamp and manually resetting the controller timer, refer to [Section 5.1.3](#).

5.1.3 Resetting Lamp Life

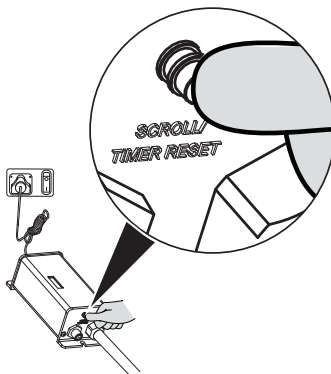

Hold down the timer reset button and reapply power to the controller until you see **RESET**, then release timer reset button. A 5 second delay will occur until you hear an audible tone and LED display will read once again **365**.

Note: Even though the alarm on the system can be deferred for a period of time, it is important to address each and every alarm condition as they are indicating that there is a potential problem with the system and should be remedied.

5.1.4 Total Days of Operation

1680 The controller also displays the total running time of the controller. To obtain this reading, press the push-button once. The total running time of the controller will be numerically displayed in days. This information will remain displayed for ten seconds and will then revert back to the lamp life remaining default screen. It should be noted that this value cannot be reset.

5.1.5 Lamp Failure (Blank Screen)

Blank When the system recognizes LAMP FAILURE (no current running through the lamp), the 4-segment display will be blank **Blank** (no default LAMP LIFE REMAINING screen) and the system will supply an intermittent audible tone (1 second on, 1 second off). The system will remain in this state, until this condition is remedied.

Section 6 Troubleshooting Guide

Problem	Possible Causes	Solution
Mechanical		
Ozone lamp is not lit	No power to unit	Check power source
	Defective lamp	Replace lamp
	Improper lamp connection	Check lamp connection
	Defective ballast	Replace ballast

Problem	Possible Causes	Solution
Ozone lamp is lit, no evidence of ozone in the pool/spa	Incorrect venturi alignment	Make sure water flows in the direction of the arrow located on venturi
	Defective/plugged venturi	Replace/clear debris from venturi
	Cracked/plugged tubing	Repair/replace any defective tubing
	Incorrect check valve positioning	Check to see if air flows away from generator
	No suction to unit	<ul style="list-style-type: none"> Repair/replace check valve Clean/replace filter cartridge
	Lamp is beyond its effective life	Replace lamp
	Lamp is dirty	Clean ozone lamp
Strong ozone smell in immediate area of generator	Retaining nuts not sealing properly	Check o-ring for debris or abrasions and re-install
	Incorrect tubing connection on outlet side of generator	Ensure proper connection is made
Alarm is sounding (audible alarm units only)	Ozone lamp is spent	Replace lamp
	Improper lamp connections	Ensure proper power connection is made
	Defective ballast or circuit board	Please contact authorized distributor
Water Chemistry		
Cloudy water	Total dissolved solids and particulates level is too high	Clean or replace filter, drain and replace water
	Incorrect pH levels	Adjust pH to be between 7.4 - 7.6
Green water	Excessive algae build-up	Shock water

DISPLAY FAULT MODES	
LED display reads "A3"	<ul style="list-style-type: none"> UV lamp life expired - countdown is at "0" days Press reset button for a deferred alarm, replace UV lamp
LED display is blank	<ul style="list-style-type: none"> Controller is in UV lamp failure mode Power system down, allowing it to reset itself; apply power in order to confirm that the controller is able to power UV lamp Check to see if there is sufficient power to the UV system

Section 7 Specifications: Standard and Validated

Model		S2Q-OZ	S8Q-OZ
Dimensions	Chamber	43.2 cm x 6.4 cm (17" x 2.5")	90 cm x 6.4 cm (35" x 2.5")
	Controller 100-250 VAC	18.6 cm x 8.1 cm x 6.4 cm (7.3" x 3.2" x 2.5")	18.6 cm x 8.1 cm x 6.4 cm (7.3" x 3.2" x 2.5")
Inlet/Outlet Port Size		3/8" Tube	3/8" Tube
Shipping Weight		2.7 kg (6 lbs)	4.5 kg (10 lbs)
Electrical	Voltage ¹	100-240 V / 50/60 Hz	100-240 V / 50/60 Hz
	Max. Current	0.6 Amp	0.6 Amp
	Power Consumption	22 W	46 W
	UV lamp Watts	17 W	37 W
UV Lamp Type		Sterilume™-EX 185NM	Sterilume™-EX 185NM
UV Chamber Material		304 SS	304 SS

¹ Units ending in "/2" are for 230V applications.

Section 8 Manufacturer's Warranty

Our Commitment

VIQUA is committed to ensuring your experience with our products and organization exceeds your expectations. We have manufactured your UV disinfection system to the highest quality standards and value you as our customer. Should you need any support, or have questions about your system, please contact our Technical Support team at 1.800.265.7246 or technicalsupport@viqua.com and we will be happy to assist you. We sincerely hope you enjoy the benefits of clean, safe drinking water after the installation of your VIQUA disinfection system.

How to Make a Warranty Claim

Note: *To maximise the disinfection performance and reliability of your VIQUA product, the system must be properly sized, installed and maintained. Guidance on the necessary water quality parameters and maintenance requirements can be found in your Owner's Manual.*

In the event that repair or replacement of parts covered by this warranty are required, the process will be handled by your dealer. If you are unsure whether an equipment problem or failure is covered by warranty, contact our Technical Support team at 1.800.265.7246 or e-mail technicalsupport@viqua.com. Our fully trained technicians will help you troubleshoot the problem and identify a solution. Please have available the model number (system type), the date of purchase, the name of the dealer from whom you purchased your VIQUA product ("the source dealer"), as well as a description of the problem you are experiencing. To establish proof of purchase when making a warranty claim, you will either need your original invoice, or have previously completed and returned your product registration card via mail or online.

Specific Warranty Coverage

Warranty coverage is specific to the VIQUA range of products. Warranty coverage is subject to the conditions and limitations outlined under "[General Conditions and Limitations](#)".

Ten-Year Limited Warranty for VIQUA UV Chamber

VIQUA warrants the UV chamber on the VIQUA product to be free from defects in material and workmanship for a period of ten (10) years from the date of purchase. During this time, VIQUA will repair or replace, at its option, any defective VIQUA UV chamber. Please return the defective part to your dealer who will process your claim.

Three-Year Limited Warranty for Electrical and Hardware Components

VIQUA warrants the electrical (power supply) and hardware components to be free from defects in material and workmanship for a period of three (3) years from the date of purchase. During this time, VIQUA will repair or replace, at its option, any defective parts covered by the warranty. Please return the defective part to your dealer who will process your claim.

One-Year Limited Warranty for Lamps, Sleeves, and UV Sensors

VIQUA warrants lamps, sleeves, and UV sensors to be free from defects in material and workmanship for a period of one (1) year from the date of purchase. During this time, VIQUA will repair or replace, at its option, any defective parts covered by the warranty. Your dealer will process your claim and advise whether the defective item needs to be returned for failure analysis.

Note: *Use only genuine VIQUA replacement lamps and sleeves in your system. Failure to do so may seriously compromise disinfection performance and affect warranty coverage.*

General Conditions and Limitations

None of the above warranties cover damage caused by improper use or maintenance, accidents, acts of God or minor scratches or imperfections that do not materially impair the operation of the product. The warranties also do not cover products that are not installed as outlined in the applicable Owner's Manual.

Parts repaired or replaced under these warranties will be covered under warranty up to the end of the warranty period applicable to the original part.

The above warranties do not include the cost of shipping and handling of returned items

The limited warranties described above are the only warranties applicable to the VIQUA range of products. These limited warranties outline the exclusive remedy for all claims based on a failure of or defect in any of these products, whether the claim is based on contract, tort (including negligence), strict liability or otherwise. These warranties are in lieu of all other warranties whether written, oral, implied or statutory. Without limitation, no warranty of merchantability or of fitness for a particular purpose shall apply to any of these products.

VIQUA does not assume any liability for personal injury or property damage caused by the use or misuse of any of the above products. VIQUA shall not in any event be liable for special, incidental, indirect or consequential damages. VIQUA's liability shall, in all instances, be limited to repair or replacement of the defective product or part and this liability will terminate upon expiration of the applicable warranty period.



425 Clair Rd. W, Guelph, Ontario, Canada N1L 1R1
t. (+1) 519.763.1032 • tf. (+1) 800.265.7246 (US and Canada only)
t. (+31) 73 747 0144 (Europe only) • f. (+1) 519.763.5069
e-mail: info@viqua.com
www.viqua.com